

电源

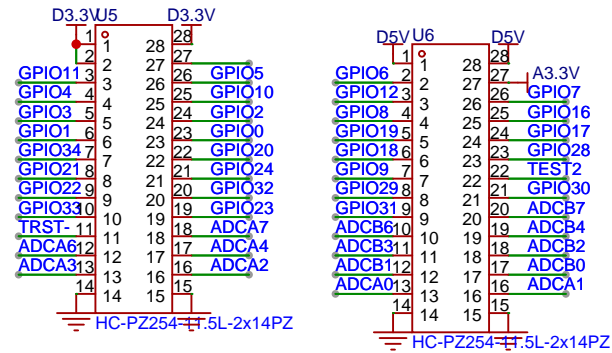

复位

JATG

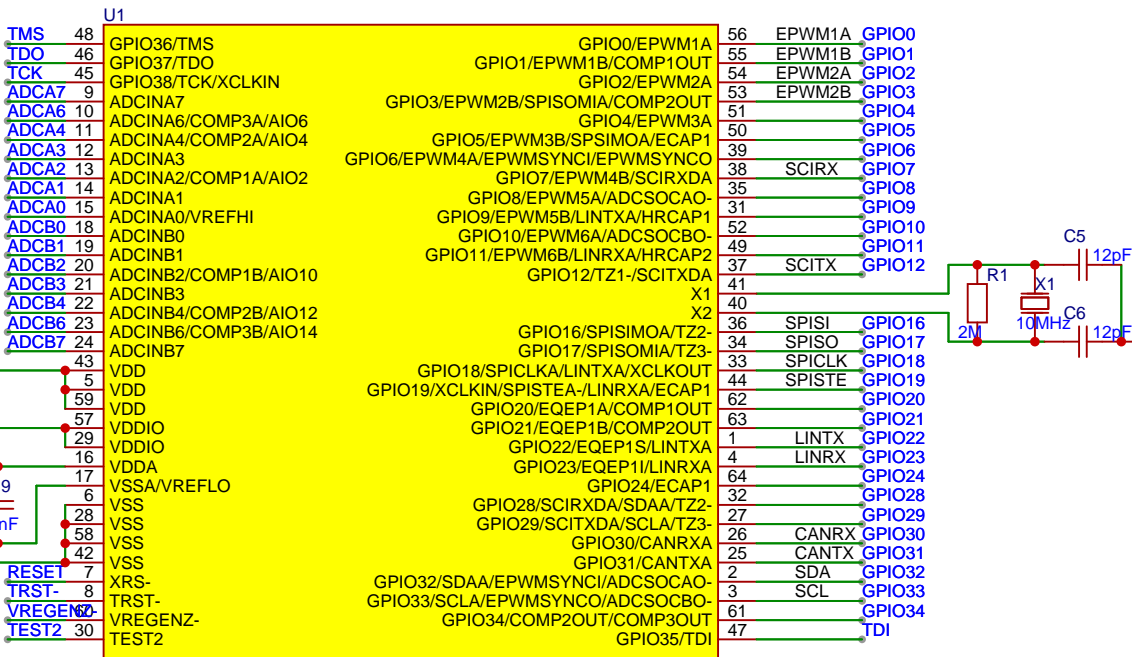
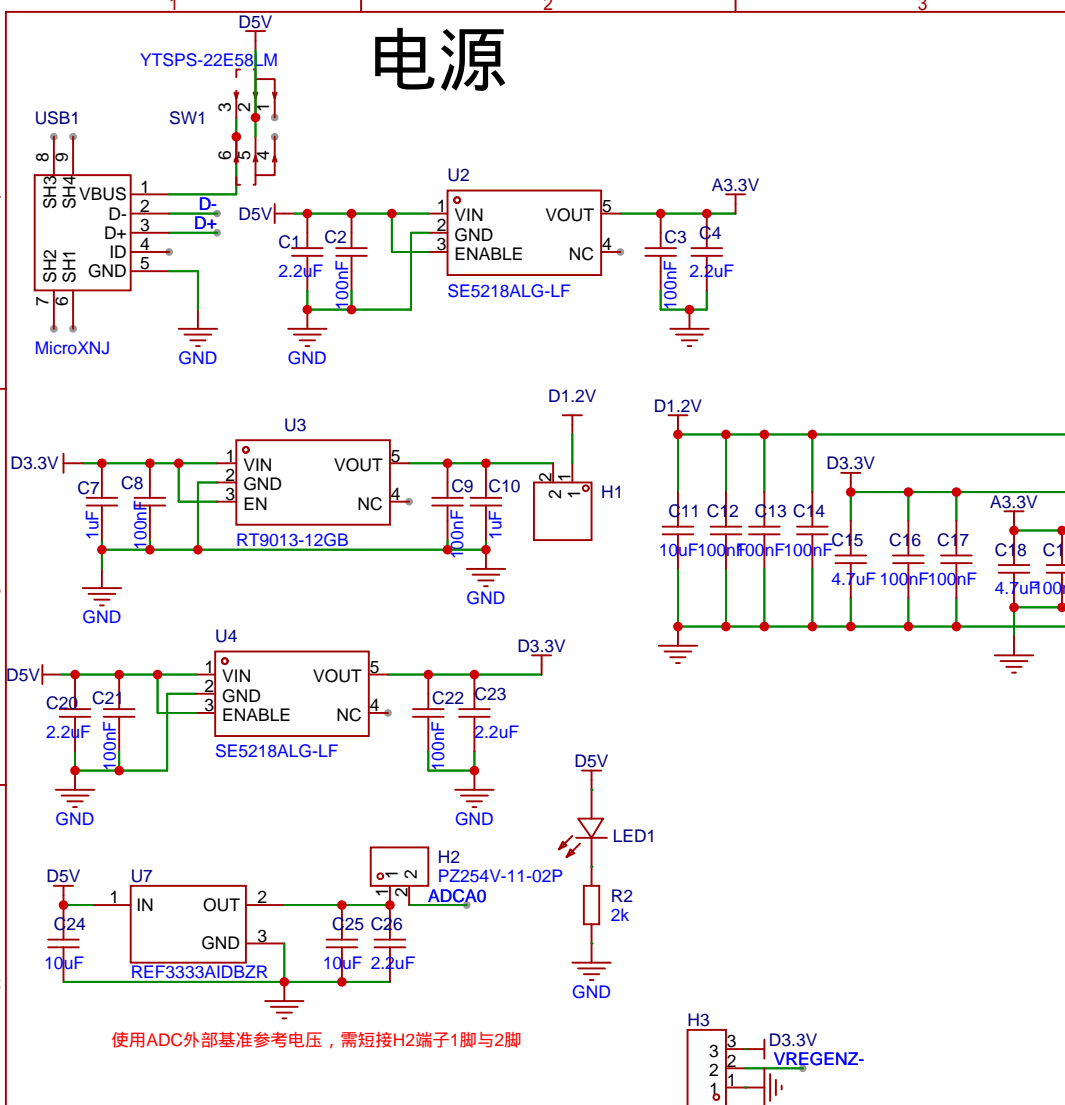
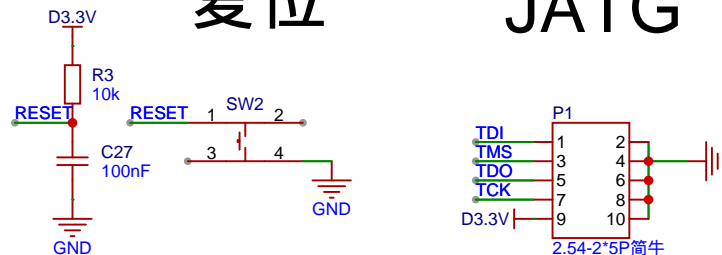

原理图	034-64PIN		创建日期	2025-06-03
板子	034-64PIN		更新日期	2025-06-09
绘制			图页	P1
审阅			QXS320F28034最小系统板	
			页 1 共 1	
		版本	尺寸	
		V1.0	A4	嘉立创EDA

电源

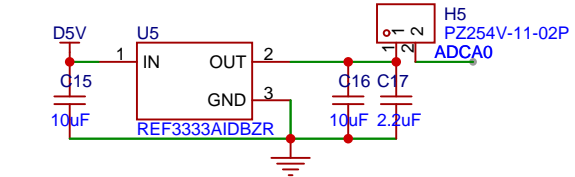
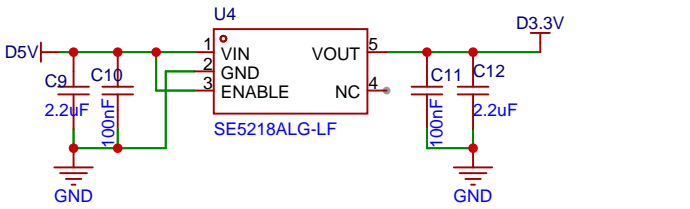
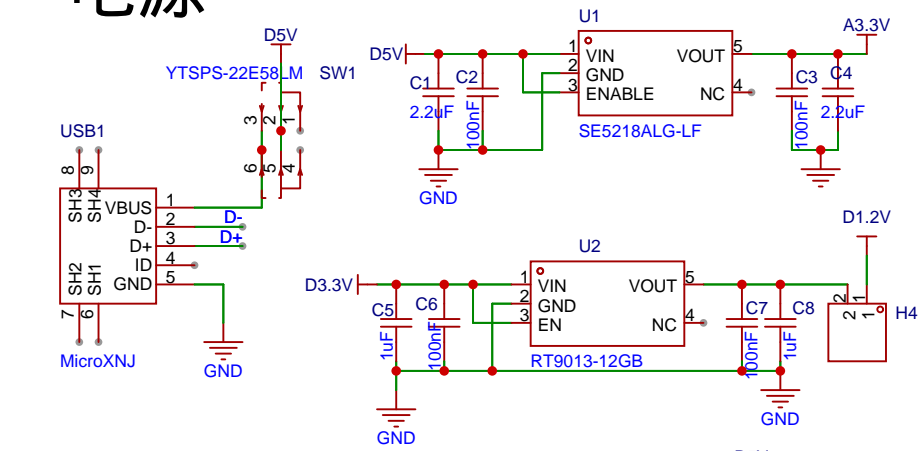

使用ADC外部基准参考电压，需短接H2端子1脚与2脚

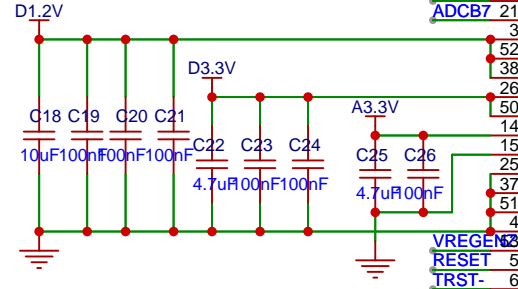
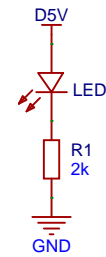
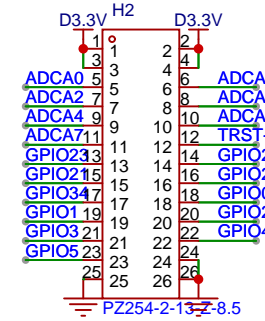
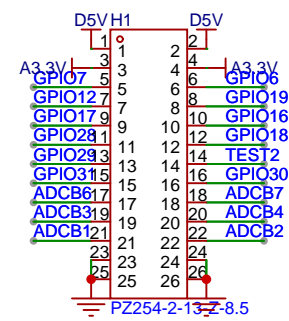
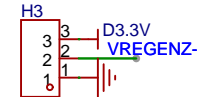

U3			
TEST2	27	GPIO0/EPWM1A	49 EPWM1A GPIO0
ADCA7	7	GPIO1/EPWM1B/COMP1OUT	48 EPWM1B GPIO1
ADCA6	8	GPIO2/EPWM2A	47 EPWM2A GPIO2
ADCA4	9	GPIO3/EPWM3A	46 EPWM3A GPIO3
ADCA3	10	GPIO4/EPWM4A	45 EPWM4A GPIO4
ADCA2	11	GPIO5/EPWM5A	44 EPWM5A GPIO5
ADCA1	12	GPIO6/EPWM6A	43 EPWM6A GPIO6
ADCA0	13	GPIO7/EPWM7A	42 EPWM7A GPIO7
ADCB1	16	X1	36 SCIRX
ADCB2	17	X2	35 SCIRX
ADCB3	18	GPIO12/TZ2-/SCITXDA	32 SCITX GPIO12
ADCB4	19	GPIO16/SPISOMOA/TZ2-	31 SPISI GPIO16
ADCB6	20	GPIO17/SPISOMIA/TZ3-	30 SPISO GPIO17
ADCB7	21	GPIO18/SPICLKA/LINTXA/XCLKOUT	29 SPICLK GPIO18
		GPIO19/XCLKIN/SPISTEA-/LINRXA/ECAP1	28 SPISTE GPIO19
		GPIO20/EQEP1A/COMP1OUT	55 EQEP1A GPIO20
		GPIO21/EQEP1B/COMP2OUT	56 EQEP1B GPIO21
		GPIO22/EQEP1S/LINTXA	1 LINTX GPIO22
		GPIO23/EQEP1I/LINRXA	2 LINRX GPIO23
		GPIO29/SCITXDA/SCLA/TZ3-	24 SCL GPIO29
		VSS	23 CANRX GPIO30
		GPIO30/CANRXA	22 CANTX GPIO31
		GPIO31/CANTXA	54 CANRXA GPIO34
		GPIO34/COMP2OUT/COMP3OUT	42 TDI
		VSS	43 TMS
		GPIO35/TDI	41 TDO
		VSS	40 TCK
		GPIO36/TMS	28 SDA GPIO28
		GPIO37/TDO	
		VSS	
		GPIO38/TCK/XCLKIN	
		TRST-	

复位

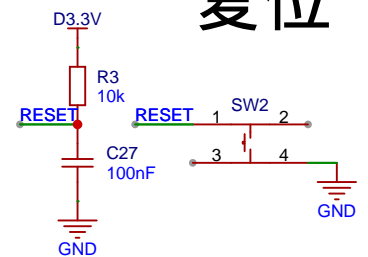

JATG

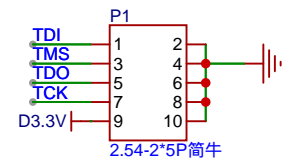

原理图	034-56PIN	创建日期	2025-05-29
板子	034-56PIN	更新日期	2025-06-09
绘制		图页	P1
审阅		QXS320F28034最小系统板	
		版本	尺寸
		V1.0	A4
		页	1 共 1
		嘉立创EDA	